

East Tester[®]

ET54XXA+ Programmable Single-Channel DC Electronic Load

User Manual



Hangzhou Zhongchuang Electron Co., Ltd



Hangzhou Zhongchuang Electron Co., Ltd

Adress: NO. 3 Kangle Road, Gongshu District, Hangzhou,China

Postcode: 310015

Telephone: 0086-571-56770222

Fax: 0086-571-56861355

<http://www.east-tester.com>

Email:sales@east-tester.com

Product Basic Function

ET54XXA+ programmable DC electronic load provides 1mV/10mV, 1mA/10mA high resolution and precision with superior performance. It is equipped with 12 common modes and complete test functions,

which can be widely used in charger, switching power supply, linear power supply, battery and other production line testing.

Key Features:

User-friendly Design:

- ◆ It adopts 2.8-inch TFT LCD screen with rich display contents;
- ◆ The operation process is simple and convenient, and with visual interface display system, it is easy to get started.
- ◆ Key lock function to prevent misoperation;

High-performance load:

- ◆ It provides CC, CV, CR, CP and CC+CV, CR+CV several basic measurement modes;
- ◆ It provides professional battery test;
- ◆ It provides professional LED test;
- ◆ The Tran test mode can test the dynamic output performance of the power supply;
- ◆ The scan test mode can test the continuity of power output within a certain range;
- ◆ The list test mode can simulate a variety of loading status changes;
- ◆ The short circuit test can be used to simulate load short circuit;
- ◆ Support external trigger input (DB9 interface is required);
- ◆ Built-in buzzer alarm;
- ◆ Maintain data storage in case of power failure;
- ◆ Remote operation via USB, RS-232 (optional) or 485 (optional) interfaces;

Multiple safety protection:

- ◆ It provides overcurrent, overvoltage, overpower, over temperature protection. The overvoltage and overcurrent parameters can be set flexibly, so as to effectively protect the load;
- ◆ It has intelligent fan speed control function, which can effectively reduce the fan noise when it is working.
- ◆ With input polarity reverse prompt;

General technical specifications:

- ◆ Power supply voltage: 100Vac±10%~240Vac±10%, 50/60Hz
- ◆ Display: 2.8-inch TFT LCD screen with resolution of 320×240
- ◆ Operating temperature: 0°C to 40°C
- ◆ Storage temperature: -10°C to 70°C
- ◆ Relative humidity: < 80%
- ◆ Interface: standard USB, optional RS232(or 485)
- ◆ Size: 90mm×190mm×300mm (width × height × depth)

Standard accessories:

- ◆ Three-core power cord * 1
- ◆ Power fuse * 2
- ◆ User manual * 1

Catalog

1.1 LCD Front Panel.....	3
1.2 Front Panel Buttons.....	3
1.3 Button Instruction.....	3
2.1 Switch Between Remote and Local Operation Modes.....	4
2.2 System Set Operation.....	4
2.3 Load Set Operation.....	5
2.4 Load Effect Test Operation.....	6
2.5 Remote Compensation Operation.....	7
2.6 Basic Mode Operation.....	7
2.6.1 Constant Current Measurement Mode.....	8
2.6.2 Constant Voltage Measurement Mode.....	8
2.6.3 Constant Resistance Measurement Mode.....	9
2.6.4 Constant Power Measurement Mode.....	9
2.6.5 Constant Current-Constant Voltage Measurement Mode.....	10
2.7 Dynamic Test Operation.....	11
2.8 List Test Operation.....	12
2.9 Scan Test Operation.....	15
2.10 Battery Test Operation.....	16
2.11 LED Test Operation.....	17
2.12 Short Circuit Test Operation.....	18
2.13 Protection Function.....	19
2.14 Trigger Function.....	19
2.15 Qualified Test Operation.....	20
2.16 Other System Set.....	20
2.16.1 Button Lock Function.....	20
2.16.2 Communication Port and External Interface Function.....	20
SPECIFICATIONS.....	22

Chapter 1 Quick Start

1.1 LCD Front Panel

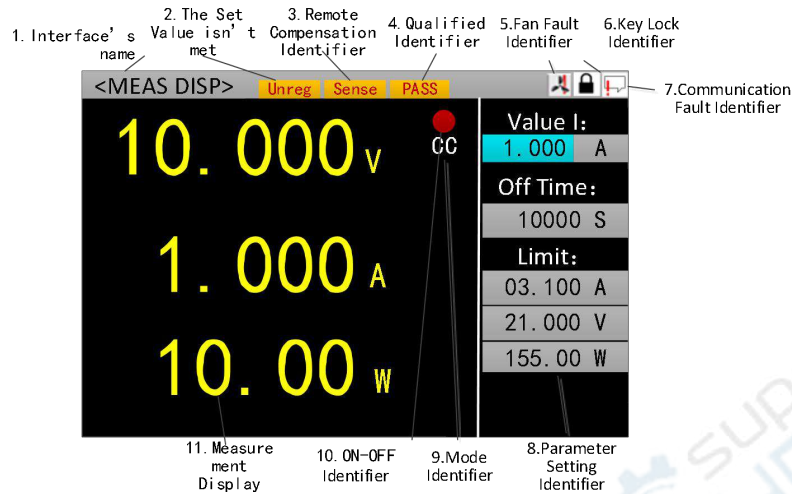

1. Interface name 2. An identification that does not meet the set value 3. Remote identification 4. Qualified identification 5. Fan fault identification 6. Button lock identification 7. Communication failure identification 8. Parameter set display 9. Mode identification 10. Switch identification 11. Main measurement display

1.2 Front Panel Buttons

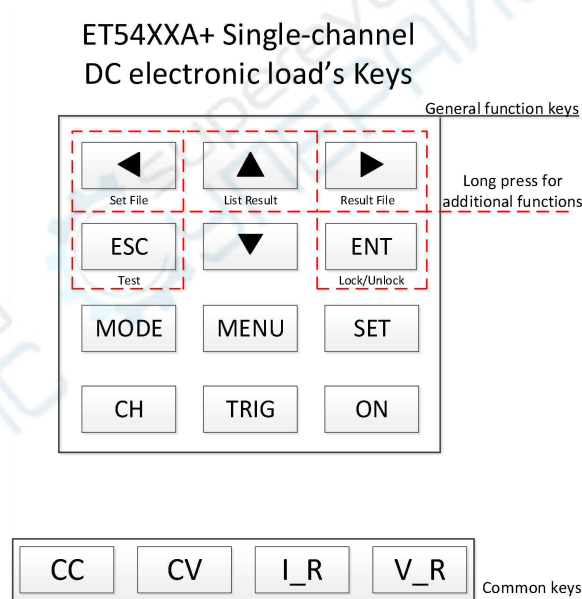

ET54XXA Single-Channel DC Electronic Load Button

Regular function button/ Commonly used button/ Additional long-press function button

1.3 Button Instruction

There are 9 regular function buttons on the right side of the display screen, including 5 additional long-press function buttons, and there are 4 commonly used buttons on the bottom of the display screen. See the following table for specific operation.

regular function buttons	Commonly used buttons	Additional long-press function buttons
◀	Cursor left movement button	Enter save interface of file list setting parameter
▶	Cursor right movement button	Enter save interface of file list result
▲	Cursor upward movement button or value-added button	Enter list test result interface
▼	Cursor downward movement button or impairment button	
ESC	Escape button	Quickly return to measurement interface
ENT	Enter button	Switch between button lock and unlock, switch between remote and local operation modes
MODE	Mode selection	
MENU	Enter system menu interface	
SET	Mode set	
CH	/	
TRIG	Trigger button	
ON	Channel switch button	

Shortcut button	Commonly used function button
CC	CC mode shortcut button
CV	CV mode shortcut button
I_R	Switch current range
V_R	Switch voltage range

Remarks: If the load is in list mode, all list related interfaces except the test interface of list test and 4 commonly used buttons will be invalid.

Chapter 2 Operation of Function

In order to ensure stable and safe operation, please be sure to connect the load and the source to be tested according to red positive and black negative before using the load to test the source to be tested. Next, turn on the source output first and then turn on the load.

2.1 Switch Between Remote and Local Operation Modes

There will be corresponding icons displayed on the top of the interface when the load is running in remote operation mode. At this time, the interface is locked. You can control the status and operation of instrument through master computer, or you can switch back to local operation mode by long pressing the [ESC] button on the panel.

2.2 System Set Operation

Press [MENU] button on any interface to enter system menu interface as shown in Chart 2.2.1. You can select through arrow buttons and [ENT] button and enter corresponding

submenu. In system set interface, you can complete the operations of language, factory data reset, startup, etc., and system set interface is shown in Chart 2.2.2. The following is a brief introduction to each interface of system menu:

- 1. Load set:** Complete related settings about load range, limit value, off delay, and whether voltage compensation is on or not.
- 2. System set:** Set load default value or last set value after the load starts up; set the language of the load to Chinese or English, turn on or off of button tone, turn on or off of warning tone, and whether to restore factory.
- 3. Communication set:** Set local address and baud rate of load communication.
- 4. Qualified set:** Set whether qualified test of the load is on, and qualified test conditions, including upper and lower limits of voltage, current and power. With qualified test being on, if voltage, current and power values of the channel are within qualified test range after the load channel starts to run, the PASS mark of corresponding channel will be displayed, otherwise the FAIL mark of corresponding channel will be displayed.
- 5. System information:** Display product model and serial number of the load, as well as hardware and software version numbers.
- 6. Load effect test:** Measure the load regulation, internal resistance of source and ΔV of corresponding channel of the load.
- 7. Remote compensation:** Measure the value of voltage drop generated by corresponding channel current on connection line. Only when this interface of corresponding channel is running, the voltage compensation for this channel is meaningful.
- 8. System menu interface operation instructions:** 1. Press [MENU] button to enter system menu interface; 2. Select operation item with **【▲▼◀▶】** arrow buttons; 3. Press [ENT] button to enter submenu interface or switch operation item; 4. Press [ESC] button to return to previous interface.

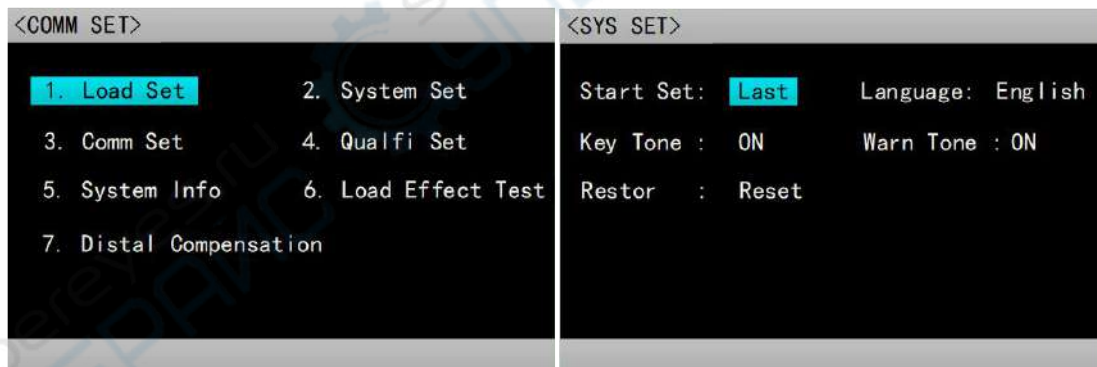

Chart 2.2.1 System Menu Interface

Chart 2.2.2 System Set Interface

2.3 Load Set Operation

You can enter load set interface through system menu, as shown in Chart 2.3. In this interface, you can complete related settings such as load range, limit value and off delay. The following is a description of setting options:

- 1. Trigger source:** External/software/manual. External trigger: input trigger signal from external interface; software trigger: send SCPI commands through remote control from external controller; manual trigger: manually press “THIR” button on the keyboard.

2. Voltage compensation: On/off. Choose to compensate or not to compensate for voltage loss between the source and load, which is reflected in voltage value displayed in measurement display interface. Note: Voltage compensation is meaningful only when remote compensation interface in system menu is running.

3. Current range: Low/high. Set maximum current allowed during load run.

4. Voltage range: Low/high. Set maximum allowable voltage during load run.

5. Maximum power: Set maximum power allowed during load run.

6. Off delay: Set runtime of basic running mode.

7. Starting voltage: Set starting voltage of the channel. If input voltage of the channel is higher than starting voltage, the channel will run.

8. Turn-off voltage: Set turn-off voltage of the channel. If input voltage of the channel is lower than turn-off voltage, the channel will be closed.

Load set interface operation instructions: 1. Select “load set” in system menu interface to enter load set interface; 2. Select operation item with **【▲ ▼◀ ▶】** arrow buttons ; 3. For non-numeric parameters, press [ENT] button to switch settings; 4. For numeric parameters, press [ENT] button to enter edit mode. Then, select corresponding digits through **【◀ ▶】** arrow buttons and adjust value through **【▲ ▼】** arrow buttons. Press [ENT] or [ESC] button to confirm input; 5. The current range and voltage range can be quickly switched by pressing [I_R] [V_R] commonly used buttons; 6. Press [ESC] to return to previous interface;



Chart 2.3 Load Set Interface

2.4 Load Effect Test Operation

Through system menu, you can enter load effect test interface, as shown in Chart 2.4. The load will run under 3 different loads and continue for a preset time respectively, and then voltage value under different loads will be recorded. This interface can measure and calculate load regulation rate, ΔV and internal resistance of source.

Operation instructions: 1. The high/low current range and high/low voltage range can be quickly switched by pressing [I_R] [V_R] commonly used buttons; 2. Select operation item with **【▲ ▼◀ ▶】** arrow buttons; 3. Press [Enter] button to enter edit Mode. Then, select corresponding digits through **【◀ ▶】** arrow buttons and adjust value through **【▲ ▼】** arrow buttons. Press [ENT] or [ESC] button to exit editing; 4. Press [ON] button to start or close the mode of selected channel;



Chart 2.4 Load Effect Test Interface

2.5 Remote Compensation Operation

Through system menu, you can enter load effect test interface, as shown in Chart 2.5. The load will run under 2 different loads, and then voltage value under different loads will be recorded, so as to compensate line loss.

Operation instructions: 1. The high/ low current range and high/ low voltage range can be quickly switched by pressing [I_R] [V_R] commonly used buttons; 2. Select operation item with **【▲▼▶▶】** arrow buttons; 3. Press [Enter] button to enter edit mode. Then, select corresponding digits through **【◀▶】** arrow buttons and adjust value through the **【▲▼】** arrow buttons. Press [ENT] or [ESC] button to exit editing; 4. Press [ON] button to start or close the mode of selected channel;



Chart 2.5 Remote Compensation Interface

2.6 Basic Mode Operation

The electronic load can work in the following basic measurement modes: constant current mode (CC), constant voltage mode (CV), constant resistance mode (CR), constant power mode (CP), constant current-constant voltage mode (CC + CV), constant resistance-constant voltage mode (CC + CR). The parameter settings of the above six modes can be set in measurement interface. Hereinto, press [MODE] button in any mode measurement interface to enter mode selection interface, as shown in Chart 2.6.

Note: 1. The setting value of basic mode operation can also be changed when the load is running.

2. The limit value of basic mode operation can also be changed when the load is running.

3. The off-delay value of basic mode operation cannot be changed when the load is running.

Operation instructions: 1. Press [MODE] button; 2. Select operation item with **【▲▼▶▶】** arrow buttons; 3. Press [Enter] button to confirm selected mode and jump to measurement interface of the selected mode; 4. If there is no selected mode, press [ESC] button to return to

previous interface; 5. CC mode or CV mode can be quickly selected by pressing [CC] or [CV] two commonly used buttons;

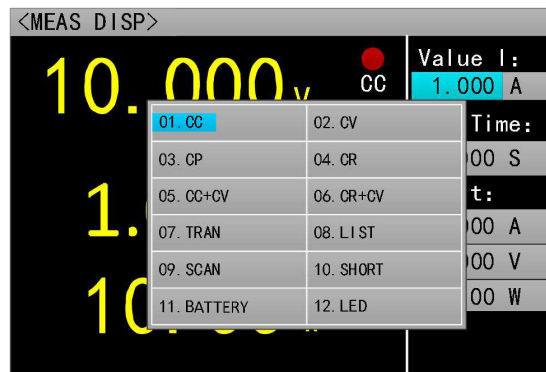

Chart 2.6 Mode Selection Interface

2.6.1 Constant Current Measurement Mode

In constant current mode, electronic load consumes a constant current regardless of whether input voltage changes.

Operating instructions: 1. Press [CC] button to enter measurement interface of CC mode; 2. The high/ low current range and voltage range can be quickly switched by pressing [I_R] [V_R] commonly used buttons; 3. Select operation item with **【▲▼◀▶】** arrow buttons; 4. Press [Enter] button to enter edit mode. Then, select corresponding digits through **【◀▶】** arrow buttons and adjust value through **【▲▼】** arrow buttons. Press [ENT] or [ESC] button to exit editing; 5. Press [ON] button to start or close the mode of selected channel;



Chart 2.6.1 Constant Current Measurement Mode

2.6.2 Constant Voltage Measurement Mode

In constant voltage mode, electronic load will consume enough current to maintain input voltage at setting voltage value.

Operating instructions: 1. Press [MODE] button to enter measurement interface of CV mode; 2. The high/ low current range and voltage range can be quickly switched by pressing [I_R] [V_R] commonly used buttons; 3. Select operation item with **【▲▼◀▶】** arrow buttons; 4. Press [Enter] button to enter edit mode. Then, select corresponding digits through **【◀▶】** arrow buttons and adjust value through **【▲▼】** arrow buttons. Press [ENT] or [ESC] button to exit editing; 5. Press [ON] button to start or close the mode of selected channel;

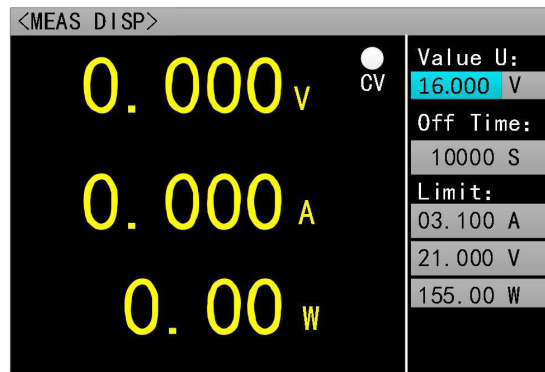

Chart 2.6.2 Constant Voltage Measurement Mode

2.6.3 Constant Resistance Measurement Mode

In constant resistance mode, the load is equivalent to a constant resistance, and the load will consume current that changes with changes of input voltage.

Operating instructions: 1. Press [MODE] button to enter measurement interface of CR mode; 2. The high/ low current range and high/ low voltage range can be quickly switched by pressing [I_R] [V_R] commonly used buttons; 3. Select operation item with 【▲▼◀▶】 arrow buttons; 4. Press [Enter] button to enter edit mode. Then, select corresponding digits through 【◀▶】 arrow buttons and adjust value through [▲▼] arrow buttons. Press [ENT] or [ESC] button to exit editing; 5. Press [ON] button to start or close the mode of selected channel;



Chart 2.6.3 Constant Resistance Measurement Mode

2.6.4 Constant Power Measurement Mode

In constant power mode, the load consumes a constant power. When input voltage changes, the load will adjust corresponding current to maintain consumed power at setting power value.

Operating instructions: 1. Press [MODE] button to enter measurement interface of CP mode; 2. The high/ low current range and high/ low voltage range can be quickly switched by pressing [I_R] [V_R] commonly used buttons; 3. Select operation item with 【▲▼◀▶】 arrow buttons; 4. Press [Enter] button to enter edit mode. Then, select corresponding digits through 【◀▶】 arrow buttons and adjust value through [▲▼] arrow buttons. Press [ENT] or [ESC] button to exit editing; 5. Press [ON] button to start or close the mode of selected channel;



Chart 2.6.4 Constant Power Measurement Mode

2.6.5 Constant Current-Constant Voltage Measurement Mode

The constant current-constant voltage measurement mode aims to prevent tested source from being damaged due to overcurrent discharge. In this mode, when the source to be tested cannot output current value set by the load, the load will automatically switch from constant current mode to constant voltage mode.

Operating instructions: 1. Press [MODE] button to enter the measurement interface of the CC + CV mode; 2. The high/ low current range and high/ low voltage range can be quickly switched by pressing [I_R] [V_R] commonly used buttons; 3. Select operation item with **▲ ▼ ◀ ▶** arrow buttons; 4. Press [Enter] button to enter edit mode. Then, select corresponding digits through **◀ ▶** arrow buttons and adjust value through **▲ ▼** arrow buttons. Press [ENT] or [ESC] button to exit editing; 5. Press [ON] button to start or close the mode of selected channel;

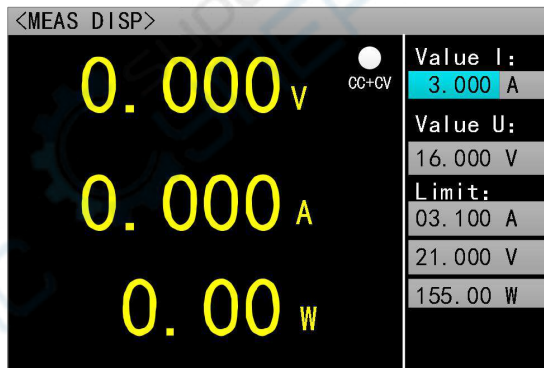

Chart 2.6.5 Constant Current-Constant Voltage Measurement Mode

2.6.6 Constant Resistance-Constant Voltage Measurement Mode

The constant resistance-constant voltage measurement mode aims to prevent measured source from being damaged due to overcurrent discharge. In this mode, when the source to be tested cannot output enough current to maintain setting resistance, the load will automatically switch from constant resistance mode to constant voltage mode.

Operating instructions: 1. Press [MODE] button to enter the measurement interface of the CR + CV mode; 2. The high/ low current range and high/ low voltage range can be quickly switched by pressing [I_R] [V_R] commonly used buttons; 3. Select operation item with **▲ ▼ ◀ ▶** arrow buttons; 4. Press [Enter] button to enter edit mode. Then, select corresponding digits through **◀ ▶** arrow buttons and adjust value through **▲ ▼** arrow buttons. Press [ENT] or [ESC] button to exit editing; 5. Press [ON] button to start or close the mode of selected channel;



Chart 2.6.5 Constant Resistance-Constant Voltage Measurement Mode

2.7 Dynamic Test Operation

The dynamic test operation can repeatedly switch set current or voltage of two kinds of load. This function can be used to test dynamic characteristics of the source. Before starting dynamic test, relevant parameters of dynamic test need to be set. Specific parameters include dynamic load state, value A, value A pulse-width time, value B, value B pulse-width time and dynamic test mode. The dynamic load state is divided into constant current and constant voltage. The set interface and test interface are shown in Chart 2.5.1 and Chart 2.5.2 respectively.

Parameter set interface operation instructions: 1. Press [SET] button to enter parameter set interface of dynamic test after entering measurement interface of dynamic test by pressing [MODE] button; 2. The high/ low current range and high/ voltage range can be quickly switched by pressing [I_R] [V_R] commonly used buttons; 3. Select operation item with **▲ ▼ ◀ ▶** arrow buttons; 4. For non-numeric parameters, press [ENT] button to switch settings; 5. For numeric parameters, press [ENT] button to enter edit mode. Then, select corresponding digits through **◀ ▶** arrow buttons and adjust value through **▲ ▼** arrow buttons. Press [ENT] or [ESC] button to exit editing; 6. Press [ESC] to return to previous interface;

Test interface operation instructions: 1. The high/ low current range and high/ low voltage range can be quickly switched by pressing [I_R] [V_R] commonly used buttons; 2. Press [ON] button to start or close the mode of selected channel;

Hereinto, dynamic test mode can be divided into three types, including continuous mode, pulse mode and trigger mode. The instructions are as follows:

- ◆ Continuous mode: In this mode, the load can continuously switch between value A and value B after starting the test.

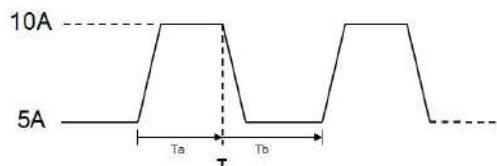

Continuous mode of operation

- ◆ Pulse mode: In this mode, the load will switch from value A to value B every time it receives a trigger signal after starting the test, and then switch to value A again after maintaining the pulse-width time of value B.

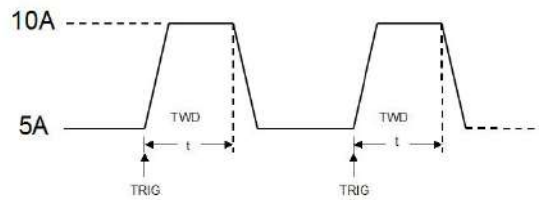

Pulses Per Second Operation Mode

- ◆ Trigger mode: In this mode, the load will switch between value A and value B every time it receives a trigger signal after starting the test. It will not work to set the pulse-width.

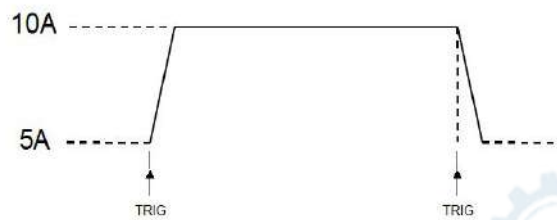

Trigger Operation Mode

<TRAN SET>	
Tran Stat: CC	Tran Mode: CONT
Level A: 3.000 A	Width A: 01000 mS
Level B: 1.000 A	Width B: 01000 mS

Chart 2.7.1 Dynamic Set Interface

<TRAN TEST>	
0.000 V	CC
0.000 A	
0.00 W	
Value A:	3.000 A
Value B:	1.000 A
Width A:	01000 mS
Width B:	01000 mS

Chart 2.7.1 Dynamic Test Interface

2.8 List Test Operation

The list test function can conveniently test running of the source to be tested under different load conditions, which is conducive to automatic test of production line. By presetting list test steps, you can edit test steps and test parameters of the source to be tested into a list and complete a series of tests in order. Specific parameters include step number set, stepping mode, cycling switch, load mode of each step, load size, delay time, comparison switch, upper limit value and lower limit value. Set interface and test interface are shown in Chart 2.6.1 and Chart 2.6.2 respectively. Test result interface after the test is shown in Chart 2.6.3, and save interface of file list setting parameter is shown in Chart 2.6.4. Save interface of file list result is shown in Chart 2.6.5, and file rename interface is shown in Chart 2.6.7.

The instructions for list test set are as follows:

1. Test step: Set the number of test items.
2. Stepping mode: Continuous/trigger. Set stepping method of test items.
3. Cycling switch: Turn on/off. Set whether the whole test process is cyclic.
4. Load mode: CC/CV/CP/CR/open circuit /short circuit.
5. Load size: Corresponding to test set value of test items.

6. Upper limit value: Set maximum value allowed in the test process after [Compare] is turned on.

7. Lower limit value: Set minimum value allowed in the test process after [Compare] is turned on.

8. Comparison: Whether to compare the value of the channel with preset upper limit value and lower limit value after starting the test. The comparable values are divided into voltage/current/power/resistance.

9. Delay: Set runtime of test items.

List test set interface operation instructions: 1. Press [SET] button to enter parameter set interface of list test after entering test interface of list test by pressing [MODE] button; 2. Select operation item with **【▲▼◀▶】** arrow buttons; 3. For non-numeric parameters, press [ENT] button to switch settings; 4. For numeric parameters, press [ENT] button to enter the edit mode. Then, select corresponding digits through **【◀▶】** arrow buttons and adjust value through the **【▲▼】** arrow buttons. Press [ENT] or [ESC] button to exit editing; 5. Press buttons under “Pre Page” or “Next Page”, i.e. [CC] and [CV] buttons, to turn the page; 6. Press the button under “Save”, i.e. [I_R] button, to enter save interface of file list setting parameter; 7. Press the button under “Test”, i.e. [V_R] button, to enter test interface of list test; 8. Press [ESC] to return to previous interface;

Test interface operation instructions: 1. Press [CH] button to select channel; 2. The high/low current range and high/ low voltage range can be quickly switched by pressing [I_R] [V_R] commonly used buttons; 3. Press [ON] button to start or close the mode of selected channel;



Chart 2.8.1 List Test Interface

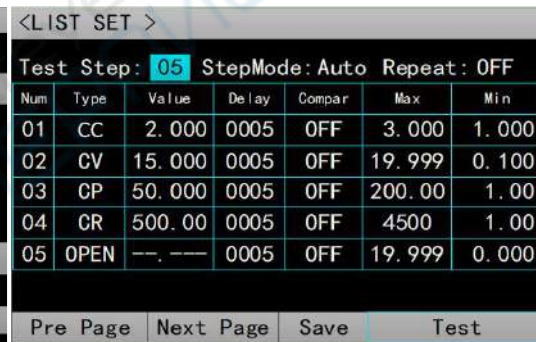

Chart 2.8.2 List Set Interface

List test result interface operation instructions: 1. Long press **【▲】** button to enter list test result interface when the mode is closed; 2. Press the buttons under “Pre Page” or “Next Page”, i.e. [CC] and [CV] buttons, to turn the page; 3. Press the button under “Save”, i.e. [I_R] button, to enter save interface of file list setting parameter; 4. Press the button under “Test”, i.e. [V_R] button, to enter the test interface of list test; 5. Press [ESC] button to return to previous interface;

<LIST RESULT>						
Test Step:05						
Num	Type	Value	Compa	Resul	Max	Min
01	CC	2.000	OFF	-----	3.000	1.000
02	CV	15.000	OFF	-----	19.999	0.100
03	CP	50.000	OFF	-----	200.00	1.00
04	CR	500.00	OFF	-----	4500	1.00
05	OPEN	--,----	OFF	-----	19.999	0.000

Pre Page Next Page Save Test

Chart 2.8.3 List Result Interface

Save interface of file list setting parameter operation instructions: 1. In list set interface, select “Save” function to enter save interface of file list setting parameter, or long press【◀】button to enter save interface of file list setting parameter when the mode is closed; 2. Select operation item with 【▲▼▶】 arrow buttons; 3. Press [ENT] button to enter edit mode, and select “Store”, “Recall” and “Delete” of the file with [▲▼] arrow buttons; 4. Press [ENT] button to enter file rename interface when “Store” is selected; 5. Press [ENT] button to enter list set interface when “Recall” is selected, and the setting parameters displayed on interface are parameter data stored in recall file; 6. Press [ENT] button to clear stored data and file name of selected file when “Delete” is selected; 7. Press the buttons under “Pre Page” or “Next Page”, i.e. [CC] and [CV] buttons, to turn the page; 8. Press [ESC] to return to previous interface;

<SET FILE>			
Current Pages			01
#####	01. Store	#####	
#####	02. Recall	#####	
#####	03. Delete	#####	
#####		#####	
#####		#####	
#####		#####	

Pre Page Next Page Edit Test

Chart 2.8.4 Save Interface of File List Setting Parameter

Save interface of file list result operation instructions: 1. In list result interface, select “Save” function to enter save interface of file list result, or long press【▶】button to enter save interface of file list result when the mode is closed; 2. Select operation item with 【▲▼▶】 arrow buttons; 3. Press [ENT] button to enter edit mode, and select “Store”, “Recall” and “Delete” of the file with [▲▼] arrow buttons; 4. Press [ENT] button to enter file rename interface when “Store” is selected; 5. Press [ENT] button to enter list result interface when “Recall” is selected, and the result displayed on interface is result data stored in recall file; 6. Press [ENT] button to clear stored data and file name of selected file when “Delete” is selected; 7. Press the buttons under “Pre Page” or “Next Page”, i.e. [CC] and [CV] buttons, to turn the page; 8. Press [ESC] to return to previous interface;

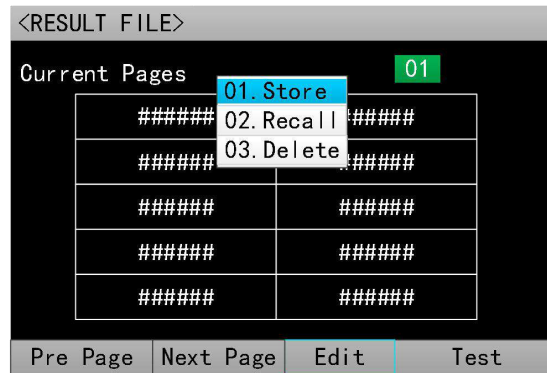

Chart 2.8.5 Save Interface of File List Result

File rename interface operation instructions: 1. Select a character with **[▲ ▼◀ ▶]** arrow buttons, and press **[ENT]** button to input character; 2. Press **[ESC]** button to clear the character if output character needs to be cleared. Press **[ESC]** button to return to previous interface after all characters are cleared; 3. Press the button under “Save”, namely **[I_R]** button to return to previous interface (save interface of setting parameter or save interface of result) after inputting file name;



Chart 2.8.7 File Rename Interface

2.9 Scan Test Operation

Scan test can be used to detect continuous run of the source to be tested within a certain range, and can easily capture various critical parameters of the source to be tested, such as protection current and break-over voltage. The user can set scan starting point, ending point, stepping amount, stepping delay, threshold type, comparison type and other related parameters. After scan test, it will display whether the test result is qualified or not, and OCP capture value will be displayed on measurement display interface.

The instructions of scan test set are as follows:

1. Scan type: Constant current / constant voltage / constant power. Set continuous running type of the source to be tested within a certain range.

2. Stepping amount: Set stepping value added at each step between scan starting point and ending point.

3. Stepping delay: Set runtime of each step between scan starting point and ending point.

4. Threshold type: Minimum voltage / voltage breakover / sag. Minimum voltage: when voltage of the load during operation is lower than threshold setting value of minimum voltage, voltage, current and power values of the load at this time will be captured and displayed on measurement display interface; voltage breakover: when the amplitude of voltage breakover during operation is higher than threshold setting value, voltage, current and power values of the load at this time will be captured and displayed on measurement display interface; voltage sag: when voltage suddenly drops sharply close to 0 during operation, voltage, current and power values of the load at this time will be captured and displayed on measurement display interface.

5. Comparison type: By voltage/ by current/ by power/off. Select whether scan test process is compared. If so, select comparison type. For example, after comparison type is set as by voltage, if voltage in the whole test process is within set value range from set lower limit voltage to upper limit voltage, scan result will be reflected in measurement display interface. The same is true for other comparison types.

6. Upper limit: Upper limit of comparison corresponding to comparison type.

7. Lower limit: Lower limit of comparison corresponding to comparison type.

Parameter set interface operation instructions: 1. Press [SET] button to enter parameter set interface of scan test after entering measurement interface of scan test by pressing [MODE] button; 2. The current range and voltage range can be quickly switched by pressing [I_R] [V_R] commonly used buttons; 3. Select operation item with **【▲▼◀▶】** arrow buttons; 4. For non-numeric parameters, press [ENT] button to switch settings; 5. For numeric parameters, press [ENT] button to enter edit mode. Then, select corresponding digits through **【◀▶】** arrow buttons and adjust value through **【▲▼】** arrow buttons. Press [ENT] or [ESC] button to exit editing; 6. Press [ESC] to return to previous interface;

Test interface operation instructions: 1. The high/ low current range and high/ low voltage range can be quickly switched by pressing [I_R] [V_R] commonly used buttons; 2. Press [ON] button to start or close the mode of selected channel;



Chart 2.9.1 Scan Test Set Interface



Chart 2.9.2 Scan Test Interface

2.10 Battery Test Operation

Battery test function is commonly used to detect battery discharge performance. The electronic load can run in mode of constant current or constant resistance. The cut-off conditions of load run include voltage, runtime, discharge capacity and discharge energy. After the load is started, battery discharge capacity and discharge energy can be automatically measured and are reflected in the measurement display interface.

The instructions of battery test set are as follows:

1. Discharge mode: Constant current / constant resistance. Set operating mode of the battery.
2. Discharge current 1 / 2 / 3: Set value of electronic load running in constant current mode.
3. Discharge resistance: Set value of electronic load running in constant resistance mode.
4. Cut-off condition: Voltage / time / energy / capacity. Set cut-off condition type for battery operation.
5. Cut-off voltage 1 / 2 / 3: Set cut-off voltage corresponding to discharge current when cut-off condition is voltage.
6. Cut-off time: Set cut-off value when cut-off condition is time.
7. Cut off energy: Set cut-off value when cut-off condition is energy.
8. Cut off capacity: Set cut-off value when cut-off condition is capacity.

Parameter set interface operation instructions: 1. Press [SET] button to enter parameter set interface of battery test after entering measurement interface of battery test by pressing [MODE] button; 2. The high/ low current range and high/ low voltage range can be quickly switched by pressing [I_R] [V_R] commonly used buttons; 3. Select operation item with **【▲▼◀▶】** arrow buttons; 4. For non-numeric parameters, press [ENT] button to switch settings; 5. For numeric parameters, press [ENT] button to enter edit mode. Then, select corresponding digits through **【◀▶】** arrow buttons and adjust value through **【▲▼】** arrow buttons. Press [ENT] or [ESC] button to exit editing; 6. Press [ESC] to return to previous interface;

Test interface operation instructions: 1. The current range and voltage range can be quickly switched by pressing [I_R] [V_R] commonly used buttons; 2. Press [ON] button to start or close the mode of selected channel;



Chart 2.10.1 Battery Test Set Interface



Chart 2.10.2 Battery Test Interface

2.11 LED Test Operation

CR-LED test can simulate characteristics of real LED lamps. By increasing turn-on voltage of diodes in traditional CR mode, the load starts to run when load input voltage exceeds turn-on voltage of diodes, which can truly reflect load capacity of LED driving source.

Operation instructions: 1. Press [MODE] button to enter LED test interface; 2. The high/low current range and high/ low voltage range can be quickly switched by pressing [I_R] [V_R] commonly used buttons; 3. Select operation item with **【▲▼◀▶】** arrow buttons; 4. Press [ENT] button to enter edit mode. Then, select corresponding digits through **【◀▶】** arrow buttons and adjust value through **【▲▼】** arrow buttons. Press [ENT] or [ESC] button to exit editing; 5. Press [ON] button to start or close the mode of selected channel;

Option Instructions:

Item	Content	Instruction
LED Vo:	0---Vmax	Stable working voltage of LED constant current source when carrying LED lamp
LED Io:	0---Imax	LED constant current source output current
LED Coeff:	0.01—1	Proportion of voltage on RD in the circuit to the total voltage

From the above parameters, turn-on voltage of LED and impedance of LED can be obtained according to the following equations (1) (2). Vf is defined as turn-on voltage of diode, and RD is defined as LED impedance value.

$$Rd = (Vo / Io) * Coeff \quad (1)$$

$$Vf = Vo * (1 - Coeff) \quad (2)$$

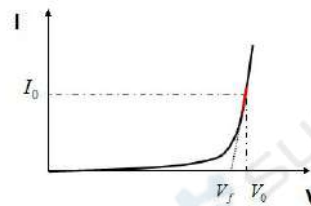

LED Characteristic curve



Chart 2.11 LED Test Interface

2.12 Short Circuit Test Operation

The load can simulate a short circuit at input end. In short circuit test, actual current consumed by the load short circuit depends on maximum output of the source.

Operation instructions: 1. Press [MODE] button to enter short circuit test interface; 2. The high/ low current range and high/ low voltage range can be quickly switched by pressing [I_R] [V_R] commonly used buttons; 3. Select operation item with [▲ ▼◀ ▶] arrow buttons; 4. Press [ENT] button to enter edit mode. Then, select corresponding digits through [◀ ▶] arrow buttons and adjust value through [▲ ▼] arrow buttons. Press [ENT] or [ESC] button to exit editing; 5. Press [ON] button to start or close the mode of selected channel;

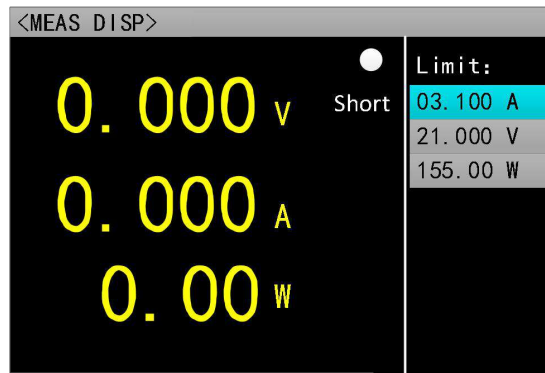

Chart 2.12 Short Circuit Test Interface

2.13 Protection Function

The load provides prompts of overcurrent, overvoltage, overpower, overtemperature and polarity reverse connection (the prompt information shall be subject to the actual picture). When the load is in protection state, other button functions are invalid before exiting protection state by pressing [ENT] button.

Equipment protection instructions:

Protection type	Type description	Protection reason
OC	Overcurrent protection	Input current is higher than the current limit value
OV	Overvoltage protection	Input voltage is higher than the voltage limit value
OP	Overpower protection	Input power is higher than the power limit value
OT	Overtemperature protection	Radiator temperature is higher than 85°C
RV	polarity reverse connection prompt	Input polarity is opposite



Chart 2.13 Overcurrent Protection Prompt

2.14 Trigger Function

The load has a trigger function, which is mainly applied in dynamic and list tests to start next conversion. The load supports three triggering methods: 1. Manual trigger (triggered by [TRIG] button on the front panel) 2. External trigger (triggered through the trigger port on rear panel). 3. Bus trigger (triggered by program control commands of RS-232 or 485 bus interface).

2.15 Qualified Test Operation

Qualified test is an additional function of basic measurement mode CC/CV/CR/CP. After qualified test is started, main interface of basic measurement mode can detect whether current test is within set limit in real time, and Pass/Fail will be displayed.

Parameter set interface operation instructions: 1. The high/low current range and high/low voltage range can be quickly switched by pressing [I_R] [V_R] commonly used buttons; 2. Select operation item with **【▲▼◀▶】** arrow buttons; 3. For non-numeric parameters, press [ENT] button to switch settings; 4. For numeric parameters, press [ENT] button to enter edit mode. Then, select corresponding digits through **【◀▶】** arrow buttons and adjust value through **【▲▼】** arrow buttons. Press [ENT] or [ESC] button to exit editing; 5. Press [ESC] to return to previous interface;

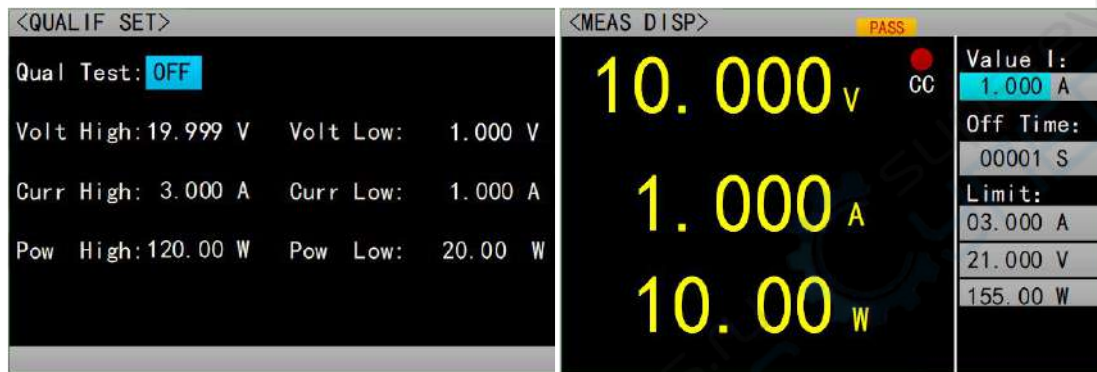

Chart 2.14.1 Qualified Test Set Interface Chart 2.14.2 Interface After Starting Qualified Test

2.16 Other System Set

2.16.1 Button Lock Function

In order to prevent users from misoperation, the load also has a lock function. The lock identification will be displayed in title bar. In locked state, except for long-press function of [ESC] button, [ON] and [ENT] buttons, all the other buttons including the knob are locked. In addition, in locked state, a locked icon will appear in icon bar, and the icon will disappear when unlocked. Long press **【ENT】** button for 3s to switch between locked and unlocked states.

2.16.2 Communication Port and External Interface Function

The ET54XXA+ series are equipped with RS232 (optional) or 485 (optional) and USB multiple communication ports. Users can choose any port to complete communication with computer. The external interfaces are status output and trigger input, which are described as follows:



Extended interface output	R1	LIST list test is in progress, low effective
	P1	List list test result is qualified, low effective
	G	GND
Extended interface	N1	External trigger input

input		
RS485/232 communication port	B/R	RS485 B pin / RS232 receiving pin
	A/T	RS485 A pin / RS232 transmitting pin
	⚡	Reference place of communication

Extended port output is OC gate output. The user needs to connect pull-up resistor and pull-up electronic level. The range of pull-up electronic level is 0-50V, and that of sinking current is 0-100ma. The equipment interface will be damaged after exceeding the above electrical range.

The extended port input is an external trigger input terminal, and falling edge is effective. The interval between two falling edges shall be greater than 100ms.

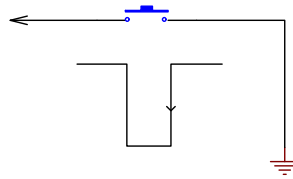

Chart 2.15.2 Communication Set Interface

SPECIFICATIONS

MODEL		ET5410A+	ET5411A+
Rated input	Power	400W	400W
	Input voltage	0-150V	0-500V
	Input current	0-40A	0-15A
CV mode	Range	0.1~19.999V,0.1~150.00V	0.1~19.999V,0.1~500.00V
	Resolution	1mV,10mV	
	Accuracy	±(0.05%+0.02%FS)	
CC mode	Range	0~3.000A,0~40.00A	0~3.000A,0~15.00A
	Resolution	1mA,10mA	
	Accuracy	±(0.05%+0.05%FS)	
CR mode	Range	0.05Ω~1 kΩ, 1 kΩ~4.5kΩ	
	Resolution	10mΩ, 100mΩ	
	Accuracy	±(0.1%+0.5%FS)	
CP mode	Range	0~400W	
	Resolution	10mW	
	Accuracy	±(0.1%+0.5%FS)	
Tran Test	Mode	CC, CV	
	T1&T2	50ms~60s;	
Battery Test	Discharge mode	CC, CR	
	Maximum discharge capacity	9999Ah	
	Resolution	1mA, 10mA, 10mΩ, 100mΩ	
Range of measurement			
Voltage read-back value	Range	0~19.999V,0~150.00V	0~19.999V,0~500.00V
	Resolution	1mV,10mV	
	Accuracy	±(0.05%+0.1%FS)	
Current read-back value	Range	0~3.000A,0~40.00A	0~3.000A,0~15.00A
	Resolution	1mA,10mA	
	Accuracy	±(0.05%+0.1%FS)	
Power read-back value	Range	400W	
	Resolution	10mW	
	Accuracy	±(0.1%+0.5%FS)	
Scope of protection			
Over Voltage Protection(OV)	>21V OR >155V over voltage protection	>21V OR >510V over voltage protection	
Over Current Protection(OC)	> 3.1 or > 42A over current protection	> 3.1 or > 16A over current protection	
Over Power Protection(OP)	410W		
Over Temperature Protection	85°C		

